



0230-0205rD

PO BOX 4394
SANTA ROSA, CA
95402 USA

P (707) 525-9941
F (707) 575-7046
EMGPICKUPS.COM

**PASSIVE
PICKUP
INPUTS**

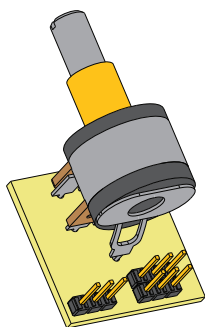

ABC (B125)
CONTROL

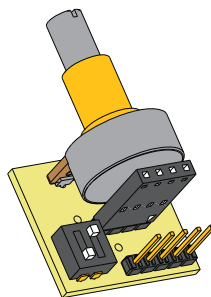

BTS (BASS)
CONTROL

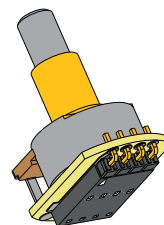

BTS (TREBLE)
CONTROL

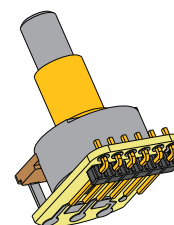

MASTER
VOLUME

INSTALLATION INFORMATION EMG MODEL: **BTS-HZ SYSTEM** (PASSIVE PICKUP INPUTS)

ABOUT THE BTS-HZ SYSTEM:

The BTS-HZ System is a complete control system for 2 Pickup Basses. Everything is included for installation into an instrument.

Included in the system are:

1) Active Balance Control (B125)

The ABC Control is designed for EMG-HZ Passive Pickups. It allows loss-free balance between two pickups and has a center detent for the middle position. If you are using EMG Active pickups, you will want to use the B118 Active Balance Control which features low impedance inputs for lower noise.

2) BTS Control (B100) 2-band equalizer for Bass guitar. The BTS features single-pole filters for broadband equalization. Often the broader single-pole filters are preferred for musical instruments because they are less selective, easier on the ear, and sound more "musical". One of the features of the BTS Control is a 2-position dip-switch that controls the slope of the high frequency response. By choosing one of the four combinations the high frequency response can be tailored to your liking. The BTS Control has a high input impedance and can be used with active or passive pickups. Bass and Treble controls are mounted on separate shafts and knobs for the complete system are included.

3) Master Volume control, output jack, battery buss and clip.

Specifications for each of the EMG products included in the BTS System are available online.

Go to: <http://www.emgpickups.com>

INSTALLATION NOTES:

BATTERY POWER:

If you play the instrument very hard, and are boosting the bass or treble with the BTS, you should consider operating the guitar on +18 Volts (2 Batteries in series, see page 4). If you play mildly and use a minimum of boost the instrument should operate easily on a single 9-Volt battery. Use an Alkaline or Lithium battery for the best battery life and always unplug your guitar when you're not using it.

WIRING ORDER:

Below is a diagram of the typical wiring order of the controls. Often the Volume control is closer to the pickups than the BTS Control making it difficult to wire the instrument. It is preferable to have the Master Volume control last in the signal chain before the output jack. If this isn't possible it's no worry, either wiring order is acceptable.

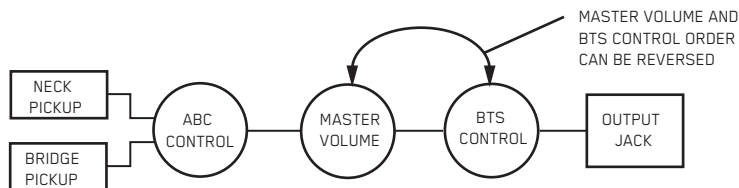

WARRANTY

All EMG Pickups and accessories are warranted for a period of two years. This warranty does not cover failure due to improper installation, abuse or damage. If upon examination the pickup is determined to be defective, a replacement will be made. Warranty replacement products are covered by this same warranty. This warranty covers only those pickups and accessories sold by authorized EMG Dealers. This warranty is not transferable.

© 2021 Copyright EMG INC. All Rights Reserved.

Installation Instructions:
EMG Model: BTS System

High Frequency Response Selection:

The BTS has the added feature of allowing you to choose from 4 different high frequency response curves. This is a nice feature especially if you are using the BTS with passive pickups. The following diagrams show the dip-switch positions and the graphs show the resultant frequency response. The BTS Control is an equalizer style control, offering both boost and cut at the same frequency locations. The controls feature a center detent (notch) that lets you know when no equalization is in effect.

BTS CONTROL (BASS BOOST & CUT RESPONSE)

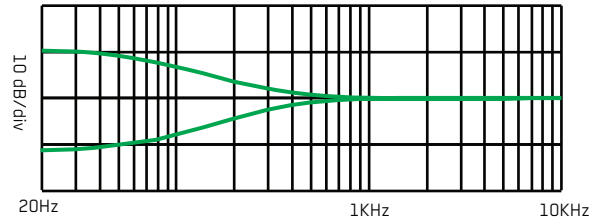

BTS CONTROL (TREBLE RESPONSE: ON/ON)

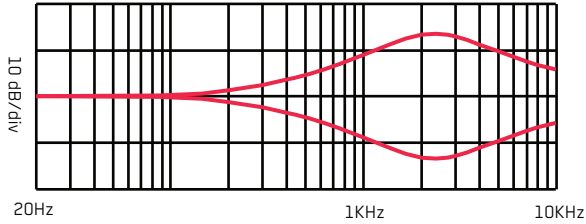

BTS CONTROL (TREBLE RESPONSE: 1 ON/2 OFF)

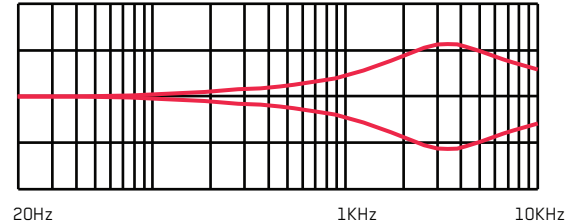

BTS CONTROL (TREBLE RESPONSE: 1 OFF/2 OFF)

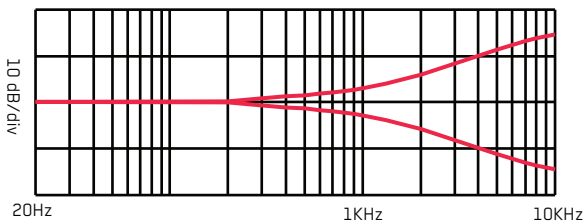

BTS CONTROL (TREBLE RESPONSE: 1 OFF/2 ON)

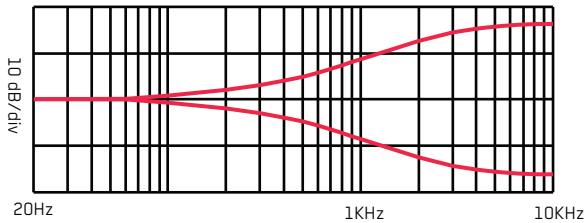

Installation Instructions:
Plug-in Pickup Inputs:

If you already have EMG Passive Pickups in your instrument you can use the existing pickup cables. Diagram #1 illustrates how to connect the pickups to the ABC Control by using the EMG plug-in connectors.

Diagram #1
EMG-HZ Plug-in Inputs & Output

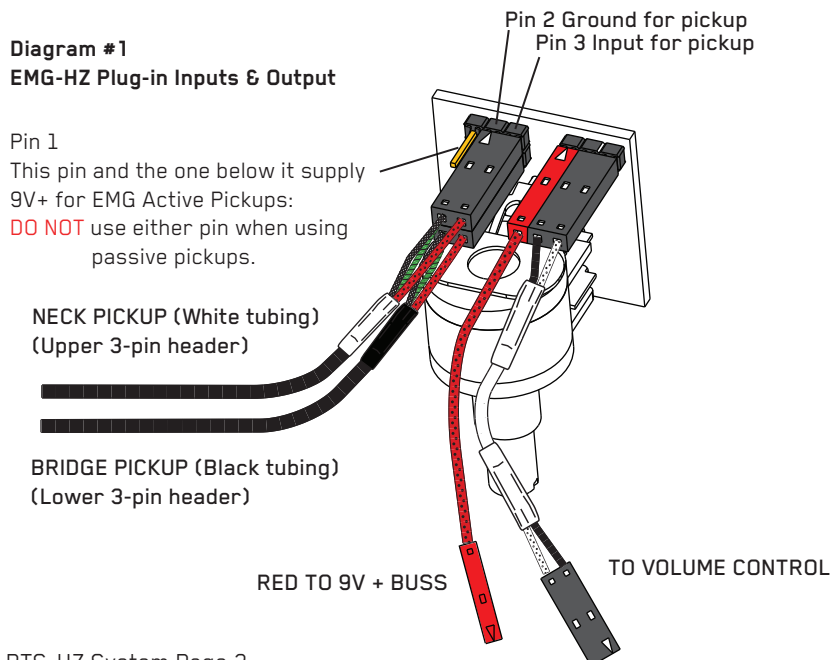

Soldered inputs:

On the back side of the ABC PC Board there are 4 pads to solder to. Solder the signal wire (Hot) of the bridge pickup to the BRG Pad, and solder the ground wire (shield) of that pickup to the GND Pad. Do the same for the Neck Pickup, Hot to the NEK Pad, and ground to the GND Pad.

Diagram #2
EMG-HZ Pickups
Soldered Inputs

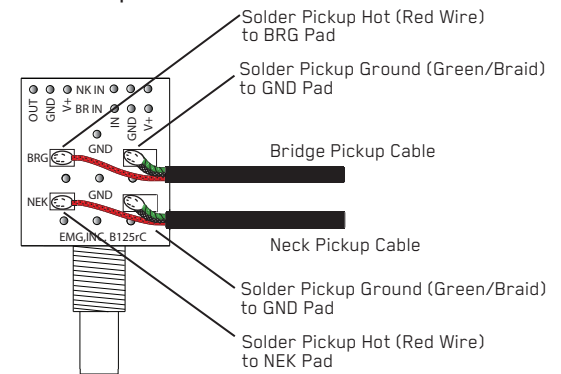

Installation Instructions:
EMG Model: BTS-HZ System

Diagram #3 (preferred wiring order)
 ABC Control
 BTS Control
 Master Volume
 Output Jack

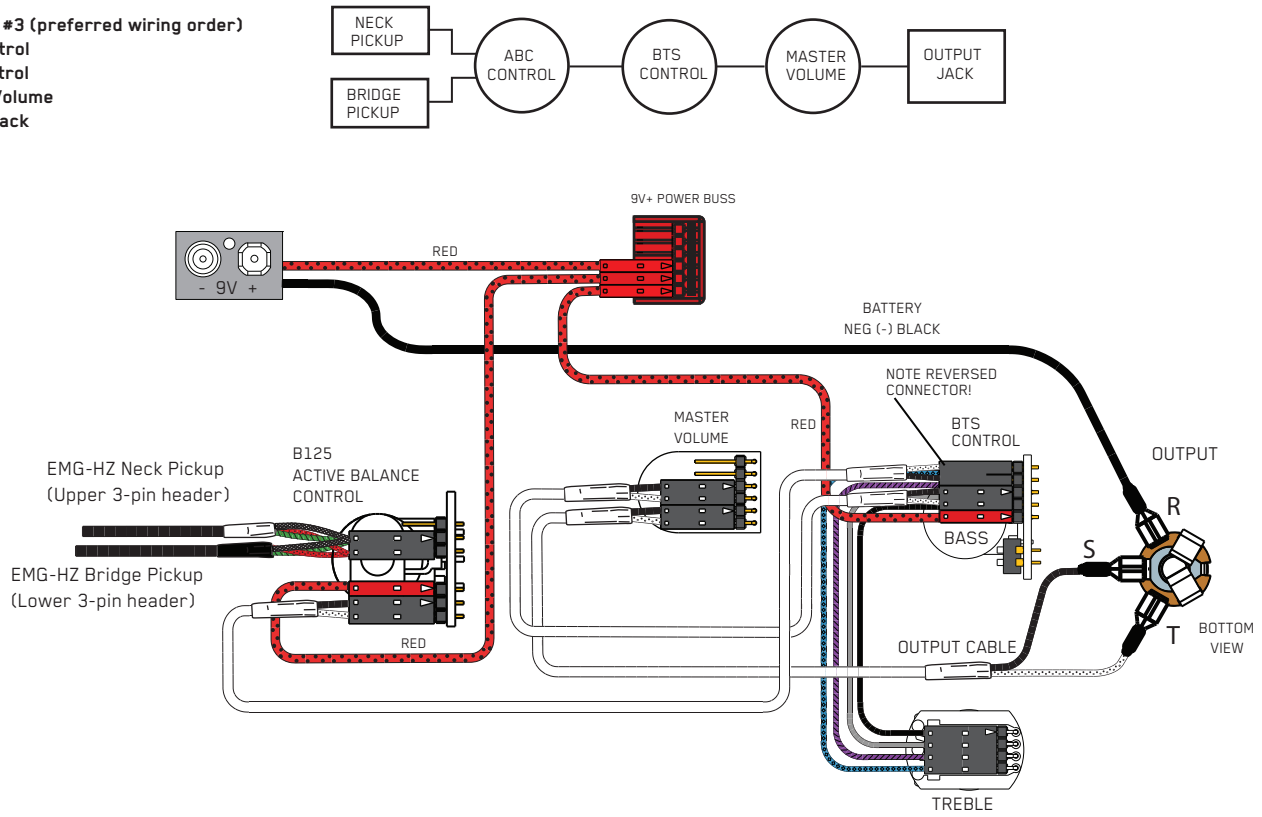

Diagram #4 (alternate wiring order)
 ABC
 Master Volume
 BTS Control
 Output Jack

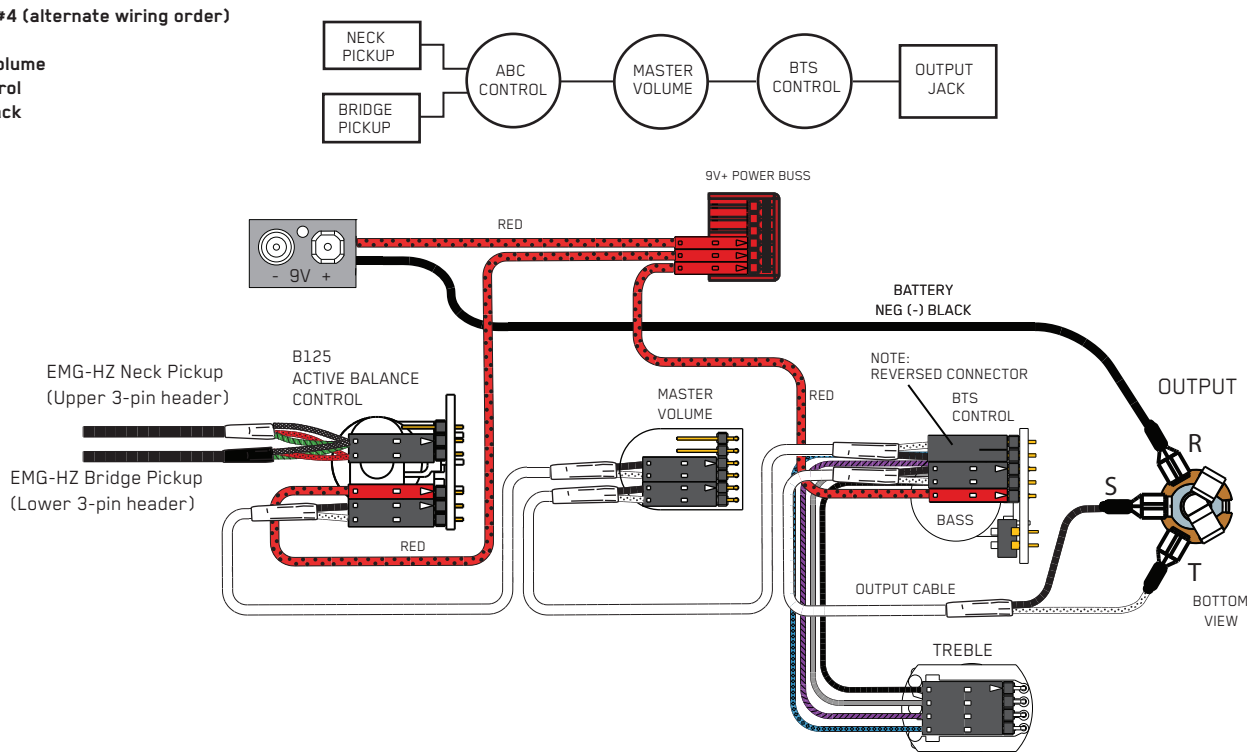

Diagram #5

If the instrument has a Battery Holder:

If your instrument has a 9 or 18-Volt battery holder you can still use the EMG Connectors to supply power to the pickups. Simply cut and strip the wires from the battery clip provided. Twist the wires together (Red to Red and Black to Black) and use the shrink tubing included to cover the connections. Soldering the wires is recommended.

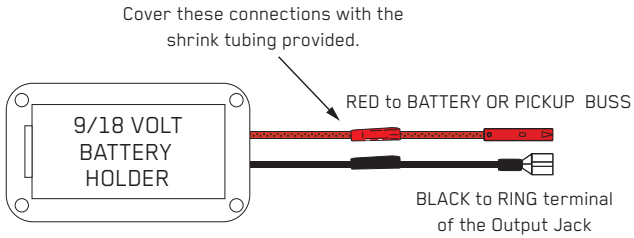

Diagram #6

+18 Volt Wiring Option:

If you want to operate your instrument at +18 Volts for more headroom then use 2 batteries wired as below. Also, if you are using any type of EQ in your instrument (EMG-BT, BQ) or anything that boosts the pickup signal then +18 Volts is recommended.

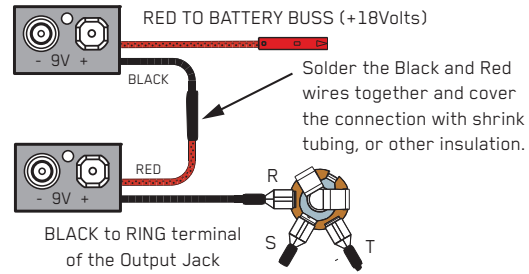

Diagram #7

Soldering to the 152B Panel Jack:

If your instrument has a long Panel Jack like the one below you will have to solder the output cable as shown. Ground (Black) to the Sleeve
Signal (White) to the Tip
Battery Negative (Black) to the Ring

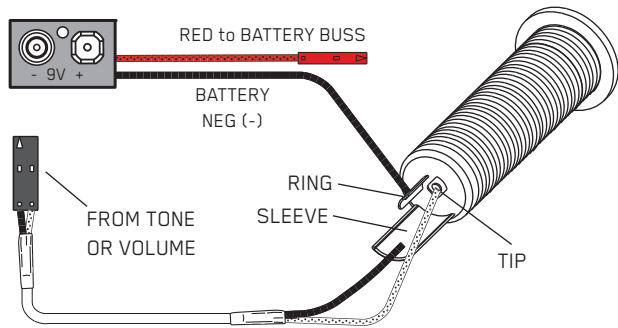

Diagram #8

Soldering to the battery buss:

If your instrument has an older EMG Pickup you can solder the pickup RED wire to the buss. Simply use some needle nose pliers, pull out the V+ header and solder the RED Wire from the pickup(s) to any of the pins and then re-insert the header into the housing.

