



0230-0166A

PO BOX 4394
SANTA ROSA, CA
95402 USA

P (707) 525-9941
F (707) 575-7046
EMGPICKUPS.COM

X-SERIES

INSTALLATION INFORMATION

EMG MODELS: S/S/S X COMBINATION SYSTEMS

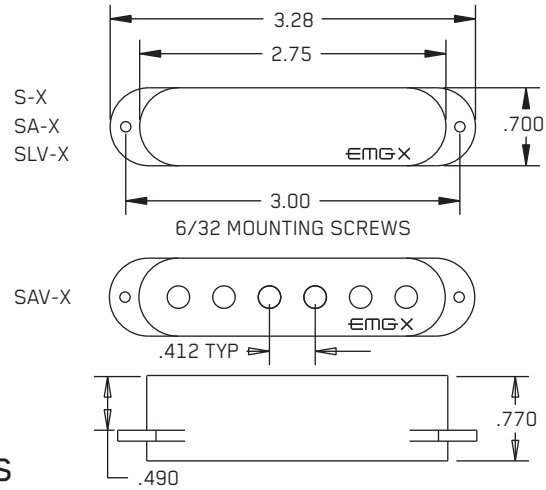
**SPECIFICATIONS (System):**

	S-X	SA-X	SAV-X	SLV-X
Logo Color	Silver	Gold	Gold	Gold
Magnet Type *	C	A	A	A
Resonant Frequency (KHz)	4.52	4.05	4.55	3.50
Output Voltage (String)	1.00	1.00	1.00	1.00
Output Voltage (Strum)	3.00	3.00	3.00	3.00
Output Noise (60 Hz)	-107	-107	-101	-103
Output Impedance (Kohm)	2.00	2.00	10	10
Current @9V (Microamps)**	1500	1500	1500	1500
Battery Life (Hours)	330	330	330	330
Maximum Supply (Volts DC)	27	27	27	27

*Note: Magnet Type: A (Alnico) C (Ceramic)

**Note: Specifications shown are for the entire 3 pickup system

INSTALLATION NOTES:

All EMG Pickups are compatible with each other. The connector system is an easy method of installation, avoiding the need to solder. Older systems may need to be soldered, while the newer systems can be easily connected and modified. If you have an older EMG Pickup you can install the new system along with it.

EMG accessories like the EXG, SPC or RPC Controls can be added to any EMG Pickup System without the need for an extra battery.

IMPORTANT INSTALLATION NOTES:

- 1) Only one 9-Volt battery is required to power the pickups and any accessories such as the SPC, RPC, EXG, AB, PA-2, and Pi-2. Use an Alkaline or Lithium battery for longest life.
- 2) The Volume control included with the EMG X System is 25K Ohm, this value is required for the system to work correctly. The tone controls are EMG's active VLPF Tone controls.
- 3) A stereo output jack (12B) is included with the EMG Pickups; it grounds the black battery wire to turn on the pickups when the plug is inserted into the jack. If you are replacing passive pickups, make sure to use the jack included. If your guitar has a long panel jack make sure it is a stereo type, a Switchcraft 152B is recommended.
- 4) When installing EMG Active Pickups, DO NOT connect the bridge ground wire. This wire is usually soldered to a volume or tone control casing and goes to the bridge. This wire grounds the strings and uses them and your body as a shield against hum and buzz. It also creates a shock hazard.

EMG Pickups are shielded internally and DO NOT require string grounding. This greatly reduces the possibility of reverse polarity shock from microphones and other equipment.

- 5) EMG Active Pickups have very little magnetism compared to passive pickups. We recommend you adjust the pickups as close to the strings as possible. Sustain and string movement will not be inhibited by close adjustment.
- 6) If your installation is different from the diagrams in these instructions or you need additional diagrams visit our website: emgpickups.com for a complete listing of available diagrams.

7) SPECIAL NOTE:

The diagrams shown are for EMG Active Pickups. All diagrams show the Red Wire coming from the pickups connected to the battery. If you are installing EMG-HZ Passive Pickups refer to their diagrams. The Red Wire of the HZ Pickup is NOT for battery power, it is a coil wire.

WARRANTY

All EMG Pickups and accessories are warranted for a period of two years. This warranty does not cover failure due to improper installation, abuse or damage. If upon examination the pickup is determined to be defective, a replacement will be made. Warranty replacement products are covered by this same warranty. This warranty covers only those pickups and accessories sold by authorized EMG Dealers. This warranty is not transferable.

Installation Instructions:

EMG-S/S/S X Combination Systems

General Notes:

Every attempt has been made to make this a solderless installation.

There are some instances where this is not possible;

- 1) If your instrument uses the long panel output jack and you had passive pickups you will need a new stereo output jack, the Switchcraft 152B is recommended. Soldering to the new jack will be required, see the Power Tips Data sheet at <http://www.emgpickups.com>.
- 2) Some instruments may already have a battery holder installed and in that case soldering may be required.

Installing EMG Combination Systems is very easy and accomplished in a few steps. The controls included have a 10 mm bushing height so they can be used either on a pickguard, or body mount. The cable lengths are designed for a pickguard, so you should make sure they are long enough if you are mounting the system into a body. Longer cable lengths may be required.

Step One:

Mount the pickups, switch and controls onto the Pickguard, or in the guitar body.

All diagrams show the B161 5-Position switch buss. To learn more about the B161 5-Position switch buss, go to the EMG Website: <http://www.emgpickups.com>.

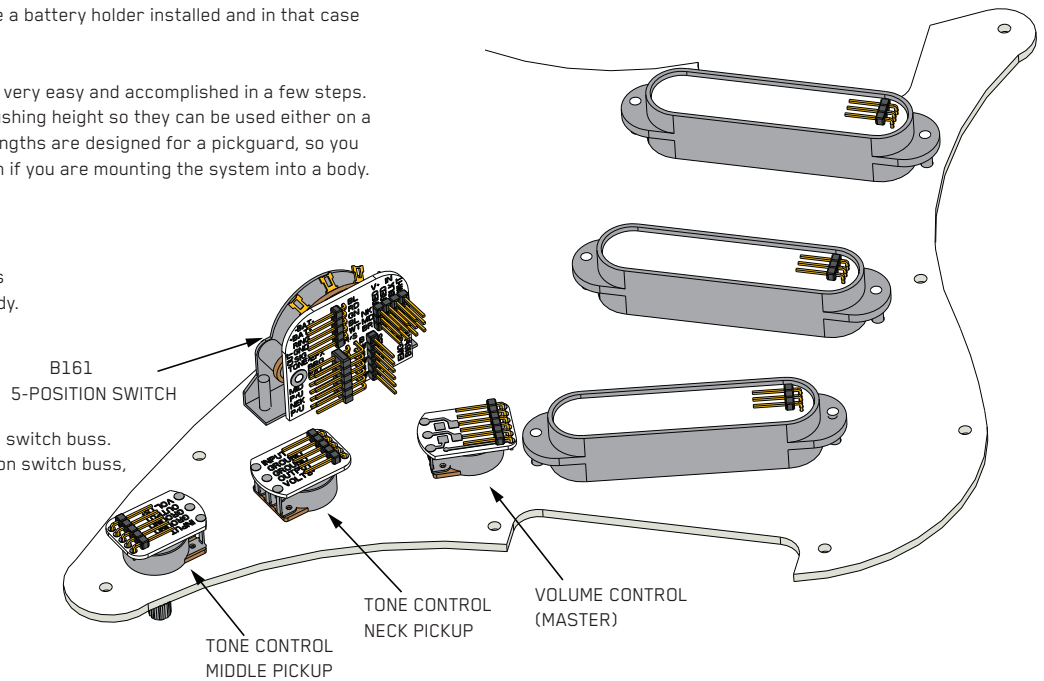

Step Two:

Plug the pickup cables onto the pickups and then onto the switch as shown.

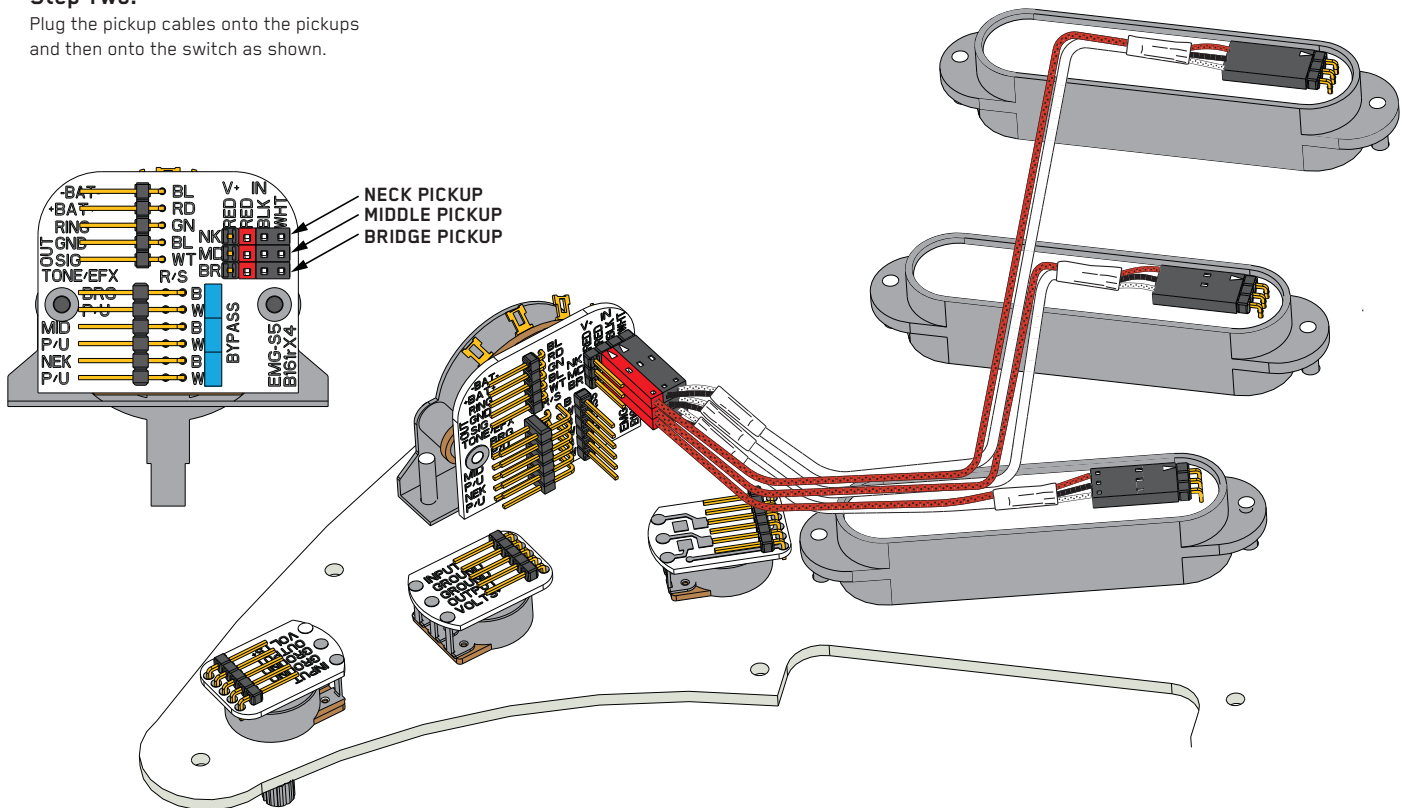

Step Three:

1) Start by installing the RETURN cables onto the inner (closest to the PC Board) 6-pin header labeled "R". Plug one cable for the Neck Pickup Tone control and one cable for the Middle Pickup Tone control.

1) Tone Returns:

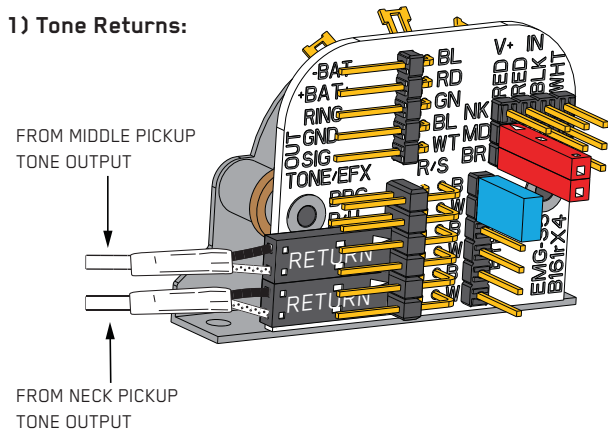

2) Install the SEND cables from the switch outer 6-pin header labeled "S". One cable to the Neck pickup Tone control and one cable to the Middle pickup Tone control.

2) Tone Sends:

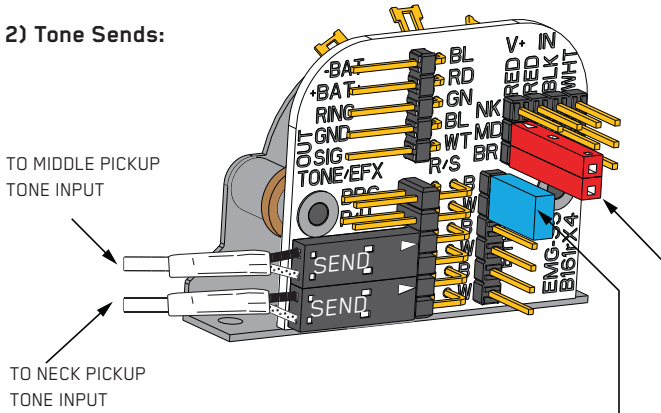

!! Don't forget to reverse the connectors on the input of each Tone control !!

Be sure to install the blue shunt on the bypass header for the Bridge Tone control and remove the shunts for both the Neck and Middle pickups.

3) Lastly, plug-in the RED wire from each Tone control to the accessory V+ Pins on the switch (near the pickup inputs) .

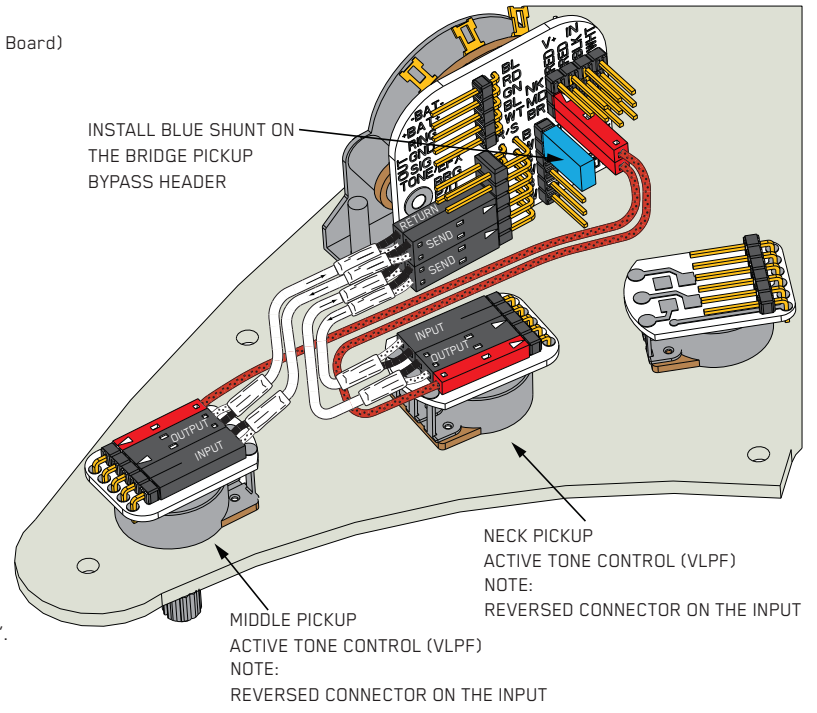

Step Four:

The Pickguard is now fully assembled. Next the pre-wired output jack needs to be mounted in the Jack plate. Mount the Jack onto the plate with the orientation as shown with the Tip spring pointing down. Refer to the diagrams below and make sure the Jack is mounted tightly.

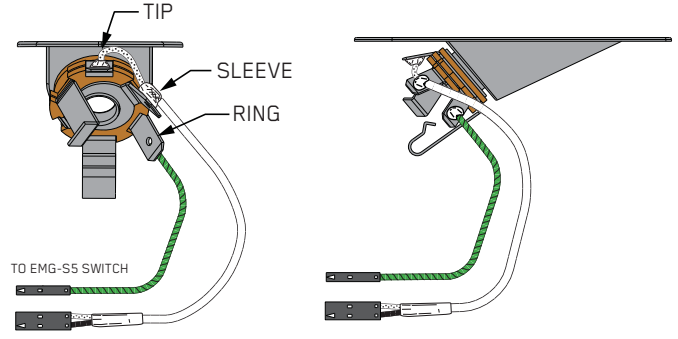

Step Five:

Route the Output cable from the Jack cavity into the control cavity via the small hole. If the hole is too small, push the connectors through one at a time. Fasten the Jack plate onto the guitar and test to make sure the cable inserts and exits easily.

Mount the battery in the control compartment. Insulate the battery using the foam insulator provided..

